

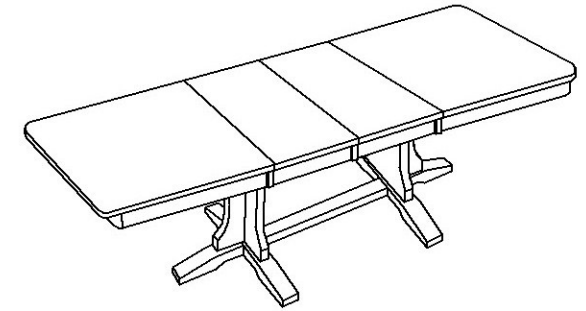



ASSEMBLY INSTRUCTIONS

(FOR CC44114)

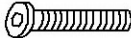
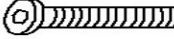

**Assemble the table on a flat, soft surface to prevent scratching the table finish. Read all instructions and study the drawings carefully before the assembly process.

Thank you for purchasing this quality product. Be sure to check all packing material carefully for small parts which may have come loose inside the carton during shipment.

PARTS LIST			
a	lock washers		12
b	washers		12
c	bolts 5/16"x45mm		6
d	bolts 5/16"x70mm		6
e	allen wrench		1

1. Turn the pedestal up side down.

2. Attach each feet to the pedestal as shown in the diagram by using bolts & washers & lock washers. Tighten all bolts firmly.

3. Turn the assembled pedestal right side up and place it in your desired location. Adjust the leg levelers at the bottom of each feet so that pedestal remains solid without rocking.

4. Attach the top onto the base and fix them by using the bolts & washers & lock washers with allen wrench.

5. Reinstall the leaf onto the table top. Close the table by pushing on the ends, and tighten the sash locks.

step 1

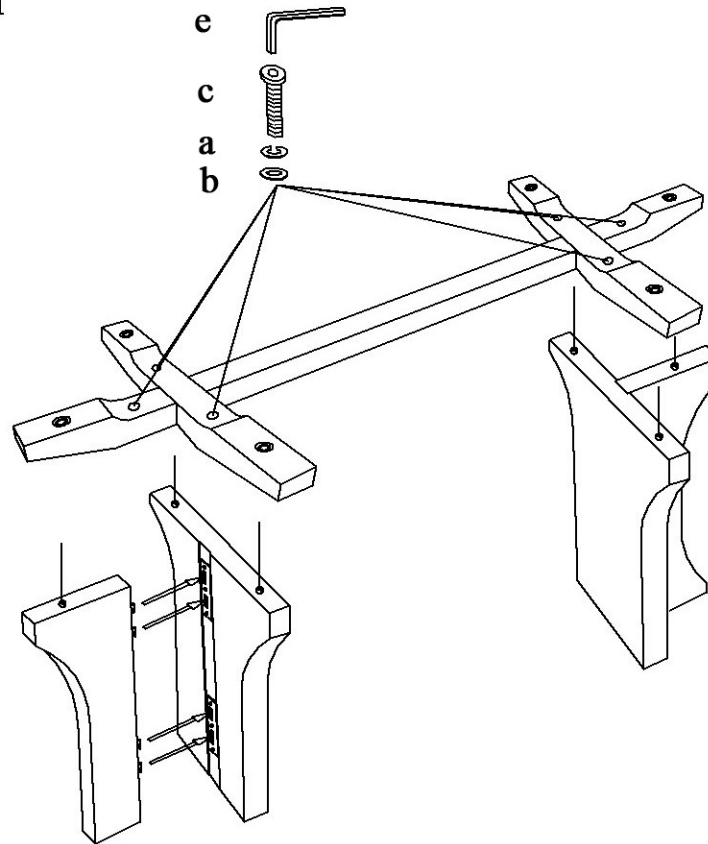

step 2

